

## ASL2XX Series switch drives

### Installation of IFU V1.2

## Declare

All rights reserved, without the written permission of the Company, any paragraph or chapter in this manual shall not be copied, copied or disseminated in any form, otherwise all consequences shall be borne by the violators.

The Company reserves all legal rights.

The Company reserves the right to modifications to the product specifications described in this manual without notice. Before ordering, please consult the local agent for the new specifications of this product

# catalogue

1. Overview.....	1
2. Product model number.....	1
3. Main technical parameters.....	1
4. Installation and wiring.....	2
4.1 Profile and installation dimensions.....	2
4.2 Electrical wiring diagram.....	4
5. Use the operation guide.....	7
5.1 Definlight definition.....	7
5.1.1 Light light of main module.....	7
5.1.2 From the module indicator light.....	8
5.2 Key-press operation.....	8
5.2.1 Description of the main module keys.....	8
5.2.2 Description of the keys from the module.....	9
5.3 liquid crystal display.....	10
5.3.2 Information query.....	11
5.3.3 Time setting.....	12
5.3.4 Timing schedule setting.....	12
5.3.5 Timed plan view.....	13
5.3.6 DI / DO linkage.....	15
5.3.7 RS485 communication settings.....	16
5.3.8 Other Parameters and information.....	17
6. Functional application.....	20
6.1 The heartbeat message.....	20
6.2 General functions.....	20
6.3 Scene function.....	20
6.4 Time function.....	20
7. The Newsletter Guide.....	20
7.1 Interface Overview.....	20
7.1.1 Transmission mode.....	20
7.1.2, information frame format.....	20
7.2 Introduction to the function code.....	21
7.2.1 Function code 03H: read register.....	21
7.2.2 Function code 10H: Write the register.....	22
7.3 Drive parameter address table.....	22
7.3.1 Drive real-time status address table.....	22
7.3.2 Parameter setting address table.....	25

7.3.3 Timing address table.....	28
7.3.4 Event record address table.....	33
8. Analysis and troubleshooting of common faults.....	36
9. Notes.....	36

## 1. summary

ASL2XX Series switch driver (hereinafter referred to as module) is the control module of Ankory ALIBUS intelligent lighting control system. The module is connected with other devices (such as smart panels, sensors, etc.) to form a complete set of lighting control system, realizing the intelligent management of large public construction and building lighting systems.

As a driver module, the module directly controls the on-off of the load power supply and realizes a variety of control functions, such as load switching, event recording, timing switch, delay light off, scene control, etc.

## 2. product model

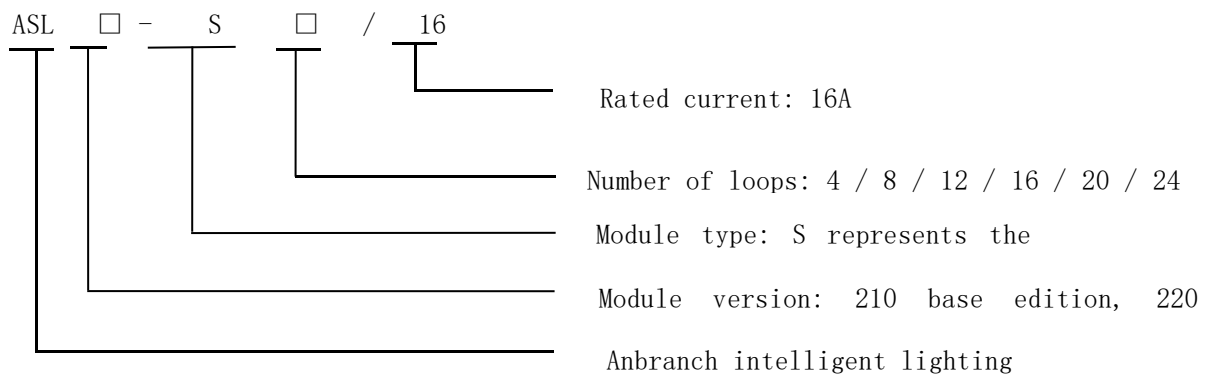

Table 1: Product Specification Table

product model	functional description
ASL220Z-Sx/16	RS485 communication, fire control linkage 2DI / 2 DO, 30 scheduled tasks (including astronomical clock), 24 scheduled tasks, LCD display, 600 switch records, 10 switch records, 12 DIDO records, split and closed channels (over zero trigger), closing times record, closing time accumulation, voltage, current measurement, electric energy statistics
ASL220-Sx/16	RS485 communication, fire control linkage 2DI / 2 DO, 30 scheduled tasks (including astronomical clock), 24 scheduled tasks, LCD display, 600 switch records, 10 switch records, 12 DIDO records, split and closing channels, closing times records, closing time accumulation
ASL210-Sx/16	RS485 communication, fire linkage 1DI / 1 DO, split and split channel

## 3. Main technical parameters

Table 2: Technical parameters table

project		metric		
		A SL220Z-Sx/16	ASL220-Sx/16	ASL210-Sx/16
Power power consump tion	rated voltage	AC220V ± 10%		
	power dissipa tion	Normal operating condition: 5W		Normal operating condition: 3W
Remote control output		Relay with dial rod, rated current 16A		
on-off input		Two passive dry contact input		There is no source dry contact input
Switch output		Two passive often open contact, contact capacity AC 220V / 1A, DC 30V / 1A		No active often open contact, contact capacity AC 220V / 1A, DC 30V / 1A
communication		ALIBUS Agreement, and the Modbus-RTU protocol		
way to install		35mm guide rail type installation		
service environment		Operating temperature: -10°C - - + 55°C; Relative humidity: 95% uncovered		
Storage temperature range		-20°C--+70°C		
Local operation interface		Key + LCD monochrome LCD display		Key + dial code switch
certainty of measurement		Voltage, current level 1 Power level 2	/	
Zero trigger		Support the relay over-zero trigger	/	

#### 4. Installation and wiring

##### 4.1 Profile and installation dimensions (mm)

- A SL220Z-Sx / 16 Switch Drive (same as ASL220-Sx / 16 switch drive)

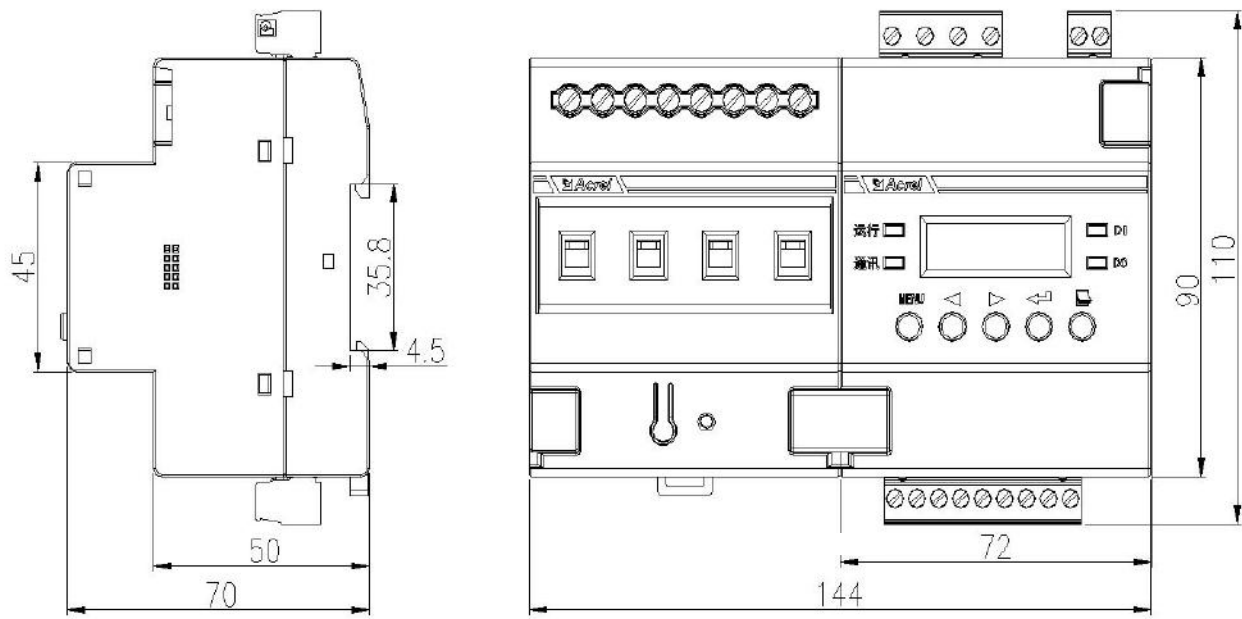

Figure 1 A SL220Z-Sx / 16 switch drive profile and installation dimensions

Table 3 ASL220Z-Sx / 16 Switswitch Model Description

product model	Number of loops	Module width (B)	modulus
ASL220Z-S4/16	4	144mm	8 Mod
ASL220Z-S8/16	8	216mm	12 Mod
ASL220Z-S12/16	12	288mm	16 Mod
ASL220Z-S16/16	16	360mm	20 Module
ASL220Z-S20/16	20	432mm	24 Mod
ASL220Z-S24/16	24	504mm	28 Mod

Installation tip: This module is suitable for 35mm guide rail installation, installation only need to put the module into the track.

- ASL210-Sx / 16 Switch drive

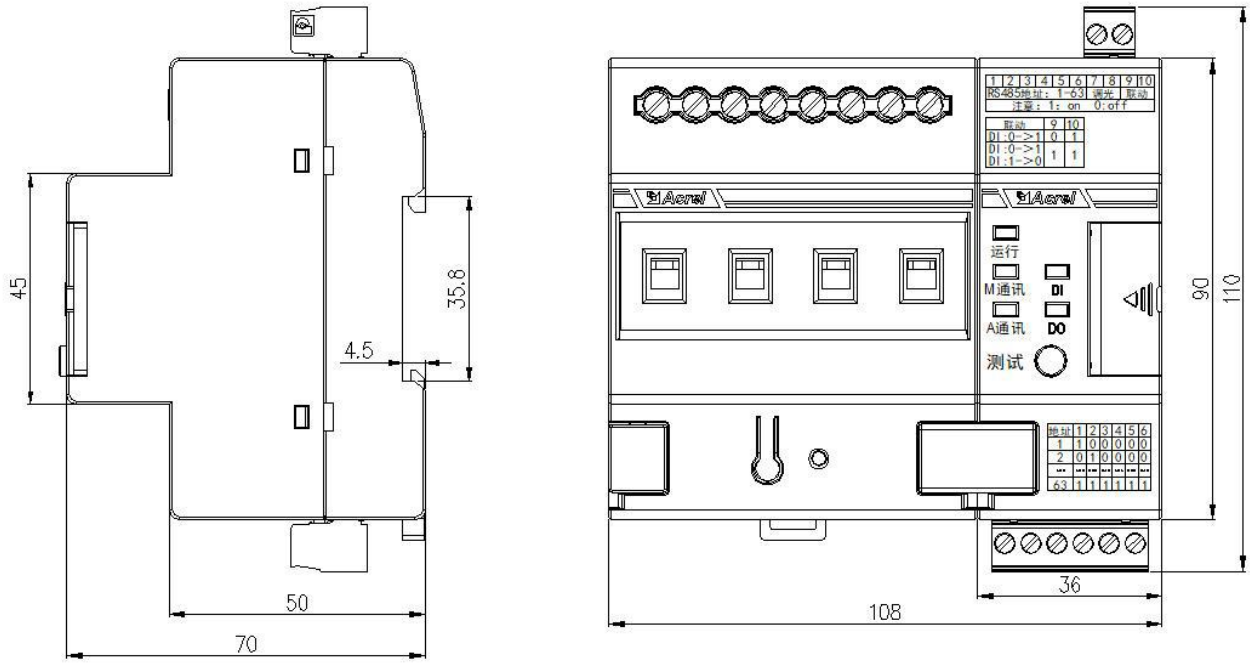

Figure 2 ASL210-Sx / 16

Table 4 ASL210-Sx / 16

product model	Number of	Module width	modulus
ASL210-S4/16	4	108mm	6 Mod
ASL210-S8/16	8	180mm	10 Module
ASL210-S12/16	12	252mm	14 Mod
ASL210-S16/16	16	324mm	18 Mod
ASL210-S20/16	20	396mm	22 Mod
ASL210-S24/16	24	468mm	26 Mod

Installation tip: This module is suitable for 35mm guide rail installation, installation only need to put the module into the track.

#### 4.2 Electrical wiring diagram

- ASL220Z-Sx / 16 Switch Drive (same as ASL220-Sx / 16 switch drive)



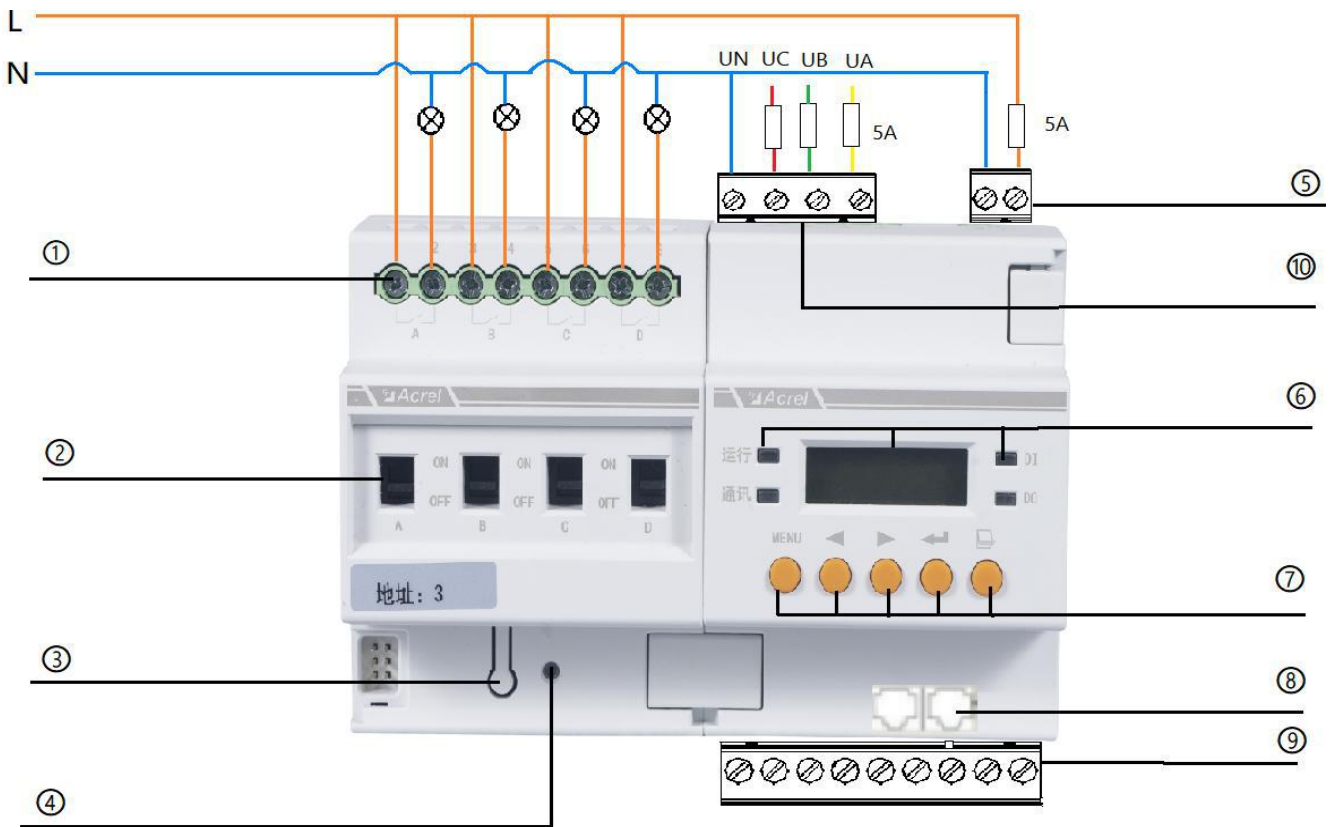

Figure 3 ASL220Z-wiring diagram of Sx / 16

Figure 3 shows the wiring diagram of the 4-way switch driver. In practical use, the 4, 8, 12, 16, 20, 24 switch driver wiring is similar, which are not listed here.

- ① Lighting circuit switch control port;
- ② Relay manual operation hole;

Note: The number of the switch loop is sorted from left to right;

- ③ Programming buttons;
- ④ working station indicator;
- ⑤ Power supply input terminal;



- ⑥ Display screen, operation / communication indicator, DI / DO indicator;
- ⑦ Operation keys: MENU menu key, left key, right key, return and turn page; ◀ ▶ ⏪ ⏩
- ⑧ ALIBUS Communication interface;
- ⑨ 485 Communication and DI / DO input terminals;



⑩ Voltage measuring terminal; (ASL220Z series switch drivers)

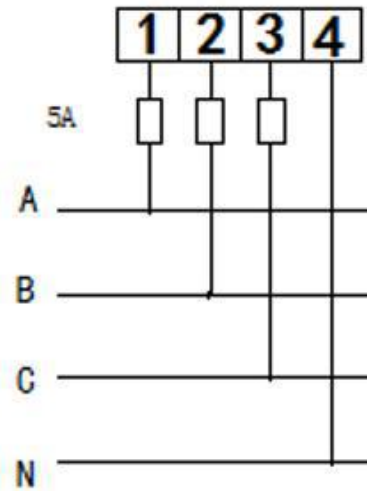

● ASL210-Sx / 16 Switch drive

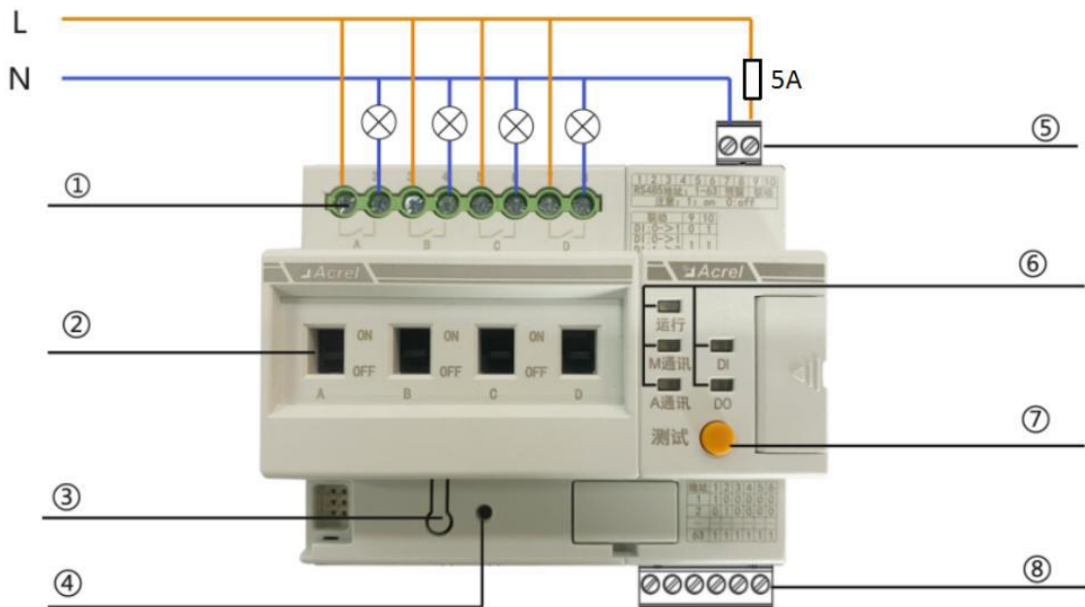

Figure 4 ASL210-Sx / 16

Figure 4 shows the wiring diagram of the 4-way switch driver. In practical use, the 4, 8, 12, 16, 20, 24 switch driver wiring is similar, and they are not listed here.

① Lighting circuit switch control port;

② Relay manual operation hole;

Note: The number of the switch loop is sorted from left to right;

③ Programming buttons;

- ④ working station indicator;
- ⑤ Power supply input terminal;



- ⑥ Operation / communication indicator, DI / DO indicator;
- ⑦ Operation ●s: test keys;
- ⑧ 485 Communication and DI / DO input terminals;



5. Use the operational guidelines

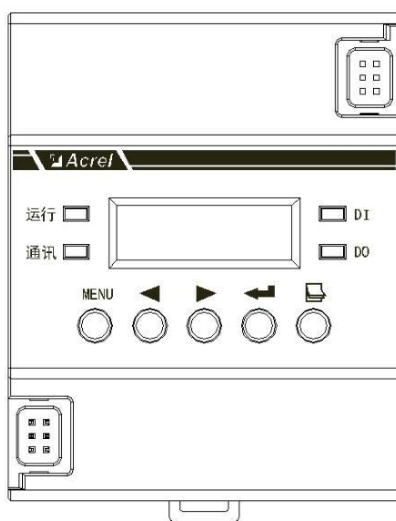

Figure 5 panel schematic diagram

5.1 Definlight definition

5.1.1 Light light of main module

(1) A SL220Z-Sx / 16 Main Module indicator lamp (the same as ASL220-Sx / 16)

Operating indicator light (green)	Flink (about once per second when the module is in normally)
Communication indicator light (green)	Blink (flash once during module ALIBUS communication) Long light (bus congestion)
DI(red)	Long light (DI signal input detected)

DO(red)	Long light (module output switch quantity signal)
---------	---

(2) ASL210-Sx / 16 main module indicator light

Operating indicator light (green)	Flink (about once per second when the module is in normally)
A Communication indicator lamp (green)	Blink (flash once during module ALIBUS communication) Long light (bus congestion)
M communication indicator lamp (green)	Blink (flash once during ModBus communication)
DI(red)	Long light (DI signal input detected)
DO(red)	Long light (module output switch quantity signal)

.25.1 From the module indicator light

From the module indicator light in green / red:

The traffic lights turn on alternately	After entering the key control mode, the traffic light shines alternately at the frequency of 1s
The traffic lights flash alternately	Traffic lights will flash alternately under normal working conditions

## 5.2 Key-press operation

### 5.2.1 Description of the main module keys

(1) A SL220Z-Sx / 16 main module button (same as ASL220-Sx / 16)

◀ ▶ ⬅ ➡ ASL220Z-Sx / 16 main module has MENU menu key, left key, right key, return key and page turning

five keys. The module can be modified to address and set parameters by pressing the button.

MENU menu key	In the non-programming mode, press this key to enter the programming mode, prompt for the password, or return to the previous menu  In programming mode, used to return to the previous menu, or exit the programming mode
◀ Left or right ▶	Unprogrammed mode: used to switch display interface, cursor displacement, or password  Programming mode: for changes to the current settings, the shift of the cursor
⬅return key	For menu item selection confirmation, and access to the next level of menu  State display interface: long press the return key to enter the channel control interface  Short press the return key to enter the power display interface
📄 Turn the page key	Unprogrammed mode: used to shift the cursor when you enter the information query interface or enter a password

	Programming mode: for cursor displacement, or linkage setting interface, for page switching
--	---

(2) ASL210-Sx / 16 main module key button

ASL210 The main module has a test button and ten dial codes, which can realize self-test, address setting and linkage setting functions.

(I) Test keys

When the code is not dialed to "OFF", press the test button for 3 seconds to enter the self-test mode.

(二) dial-up

1	2	3	4	5	6	7	8	9	10
RS485 Address: 1-63						obligate	linkage		
Note 1: on 0: off									

① RS485 address

address	1	2	3	4	5	6
1	1	0	0	0	0	0
2	0	1	0	0	0	0
...	...	...	...	...	...	...
63	1	1	1	1	1	1

② Linkage function

Note: here is only ASL210-Sx / 16 linkage function; for details, see "5.3.6 DI / DO linkage" for ASL220-Sx / 16.

7,8 Dial-up code: invalid, function reserved

9 Code: linkage mode selection, mode 0 means that when the DI signal input is detected, the channel moves according to the preset action value

Mode 1 represents that the channel moves according to the preset action value when the DI signal input is detected; when the DI signal withdrawal is detected, the channel moves backwards according to the preset action value

10 Dial code: linkage function enabled, 0 represents off, 1 represents on;

linkage	9	10
DI: 0->1	0	1
DI: 0->1 1->0	1	1

The opening and the execution of the channel should be set by ModBus-RTU. The relevant register definition is shown in "7.3.2 DI Settings Address Table".

Example 1: Set DI1 linkage, DI1 detects 1-8 channels when signal arrives; 1-8 channels after signal

removal.

Step 1: open the linkage function, set it to mode 1:9,10 dial code to on terminal;

Step 2: Enable the 1-8 channel: register 0x0105,0x0106 write 0x0000,0x00ff;

Step 3: Set the 1-8 channel action value as 0: register 0x0107,0x0108 write 0x0000,0x00ff;

Note: The action value of "1" indicates the corresponding channel combination, and "0" indicates the corresponding channel fraction

### 5.2.2 Description of the keys from the module

The control function can be realized from the module button: long press and short press.

Short press	In the control mode, the short press can be the channel full combination or full split
Long press	After pressing the button for 3s, you can enter the control mode; another 3s will exit the control mode
	The control mode is also automatically withdrawn after 15s without the operation

## 5.3 liquid crystal display

ASL220Z-Sx / 16, ASL220-Sx / 16 type comes with liquid crystal display, with switch drive status query, information query, time and timing plan query and setting, DI / DO linkage query and setting, RS485 communication function query and setting, other parameters query and setting.

### 5.3.1 Switch drive status query

1) Power-on, shutdown and self-test

At the moment of power up, the switch drive interface is shown in the following figure, all indicator lights turn on at the same time, the module conducts self-test, the interface is shown in the following figure, all indicator lights are off in turn, and the final operation indicator lights flicker to enter the normal monitoring state.

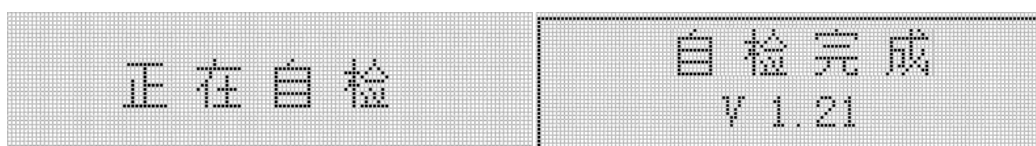

2) State display interface

After self-test, enter the state display interface. The first line shows the current date, week and time, and the bottom two rows show the channel status, output (DO) and input (DI) status of each module respectively.

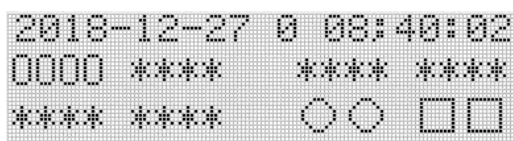

Note: □ represents DI disconnected, ■ represents DI closed, ○ represents DO disconnected, and ● represents DO closed.

0 means that the channel is divided, 1 means that the channel is closed, \* the loop is not

connected, -- means that the loop is disconnected.

### 3) Channel recording interface

◀ ▶ In the status display interface, press the left key or the right key to enter the channel, the first line shows the current state of the channel and the number of opening and closing times of the channel, and the second line shows the cumulative time of channel closure. At the channel recording interface, press the left or right key to switch the next channel record. ◀ ▶

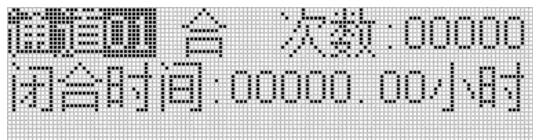

### 4) Channel control interface

↵ Press the return key for 3s on the state display interface to enter the channel control interface to control the channel from the module and display the channel and the control state to be controlled. After the test, press the MENU menu key to exit.

Note: Channel 00 means all channels, channel 01 represents the first channel, and so on.

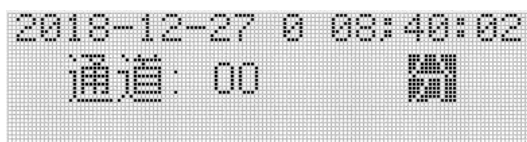

### 5.3.2 Information query

☞ Under the status display interface, press the page turning key to enter the information query interface, press the left key or the right key to switch the record, and press the return key to enter. ◀ ▶

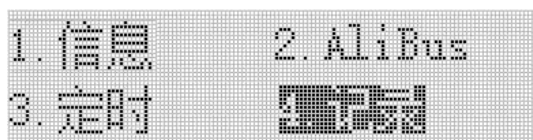

◀ ▶ In the information query interface, press the left button or right button to switch switch record, open machine, DIDO record, press the return key to enter.

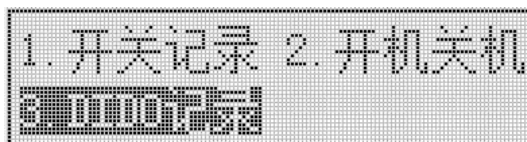

① Switch record interface can view 600 switch action records, the interface shows the channel, status, source and time of each action. Press the left or right button to switch the next record. ◀ ▶

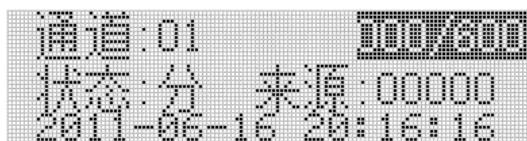

② Open machine interface can view 10 modules open machine records, the interface shows the channel status after each startup (shutdown) and the time of boot (shutdown). Press the left or right button to switch the next record. ◀ ▶

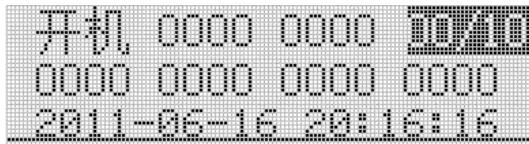

③ DIDO record interface can view 12 DI / DO action records. The interface displays the state of the DI / DO after each action and the time of the action. Press the left or right button to switch the next record. ◀ ▶

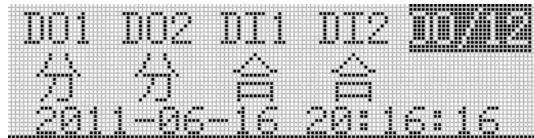

### 5.3.3 Time setting

Press MENU to enter the programming password interface: press the flip key and left or right key, enter the user password (the default password is 0001), and press the enter key to enter. After the password is correct, enter the programming interface. Press the left button or right button to switch the time setting, and press the return key to enter the next level menu for setting. ◀ ▶◀▶

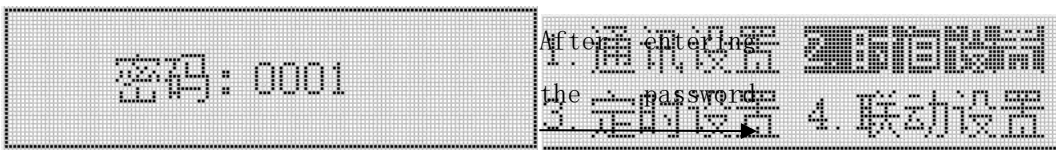

Under the "Time Settings" interface, the year, month, day, week (Sunday, represented by 0), time, time zone, longitude, latitude and longitude can be modified or set;

Note: + 08 means the East eight, -08 means the West eight, other time zones and so on.

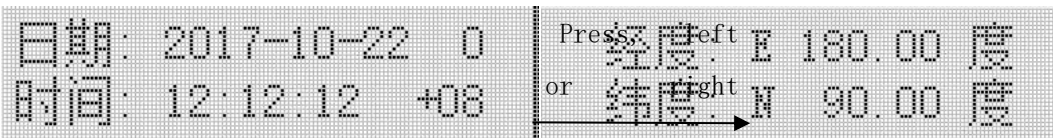

After the setting is completed, press MENU to return until whether to save the setting interface. Then select whether to save the data by pressing the left or right keys, and press the return key to confirm and exit the setting interface. ◀ ▶◀▶

### 5.3.4 Timing schedule setting

Press the MENU key, enter the programming password interface, press the page turn key or the left key, enter the user password (the default password is 0001), and press the enter key to enter. After the password is correct, enter the programming interface. Press the left button or right button to switch the timing setting, and press the return key to enter the next level menu for setting. ◀ ▶◀▶◀▶



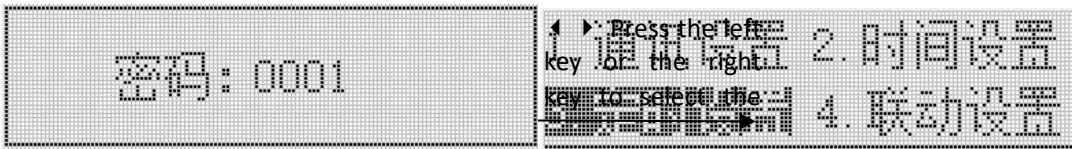

◀ ▶ ◀ Under the "timing setting" interface, press the left or right keys to switch the scheduled tasks and the scheduled tasks, and press the return key to enter. In the interface of "timing setting", select the first line "Zero zero" and press the return key to confirm, which can clear all the regularly specified tasks; select "Zero zero" in the second line to confirm, which can clear all the scheduled tasks. ◀ ▶



(1) Under the interface of "regular tasks", 30 regular tasks can be set or modified. The first interface can set or modify the task time and type (the timing to the channel, the timing to the channel); the second interface can set or modify the channel to be controlled (1 means that the channel is enabled, 0 means that the channel is not enabled).

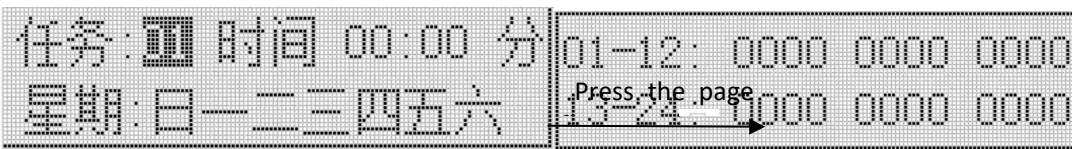

(2) Under the "Appointment Scheduled Task" interface, 24 scheduled tasks can be set or modified. The first interface can set or modify the task time and type (the timing to the channel, the timing to the channel); the second interface can set or modify the channel to be controlled (1 means that the channel is enabled, 0 means that the channel is not enabled).

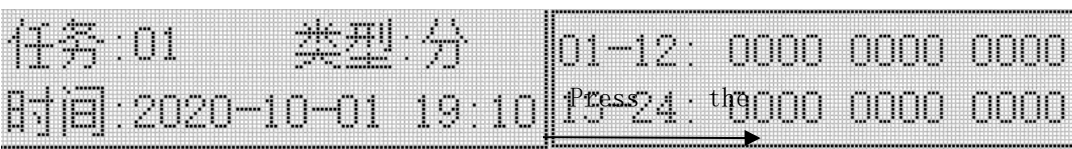

After the setting is completed, press MENU to return until whether to save the setting interface. Then select whether to save the data by pressing the left or right button, and press Enter to confirm and exit the setting interface. ◀ ▶ ◀

### 5.3.5 Timed plan view

◀ ▶ Under the status display interface, press the page turning key to enter the information query interface, press the left key or right key to switch timing, press the return key to enter the next level menu for viewing. Under the timing interface, press the left button or right button to switch the scheduled tasks and the scheduled tasks, and press the enter key to enter. ◀ ▶

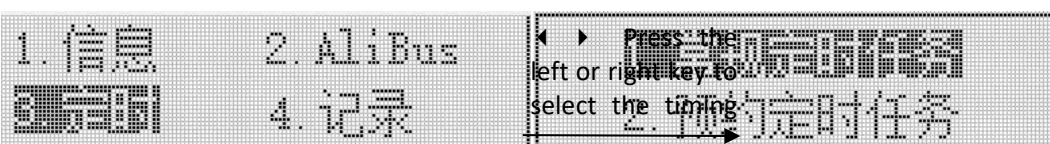

(1) The often specified task interface can view 30 tasks. The first interface shows the time and type of each task

(the timing reaches the channel opening, the timing reaches the channel closing) and week, and the second interface displays the controlled channel. Press the left or right button to switch the next task. ◀ ▶

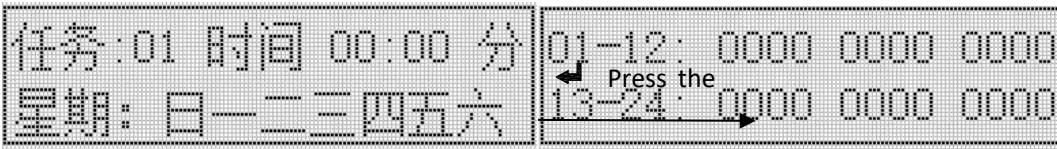

(2) The scheduled timing task interface can view 24 tasks. The first interface shows the type of each task (the timing reaches the channel, the timing reaches the channel) and the time, and the second interface displays the controlled channel. Press the left or right button to switch the next task. ◀ ▶

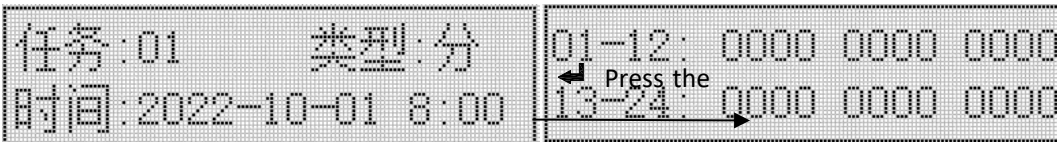

Example 1: Set the regular time task, and close all the channels at 18:00 every day.

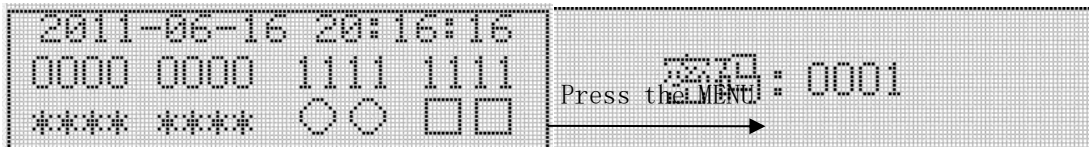

After entering the password, press the Enter key to

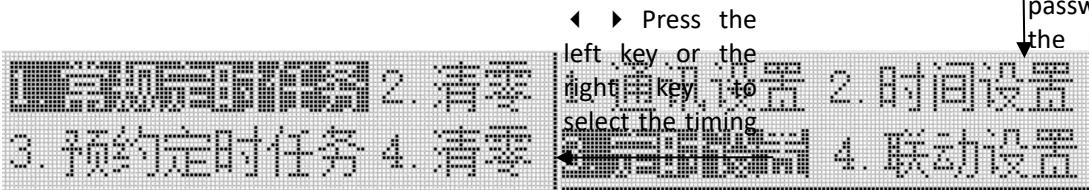

◀ ▶ Press the left or right key to select the specified task, press

◀ ▶ Press the left key or right key, return key to

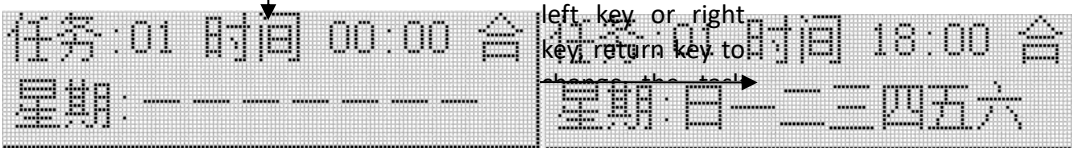

Press the page flip

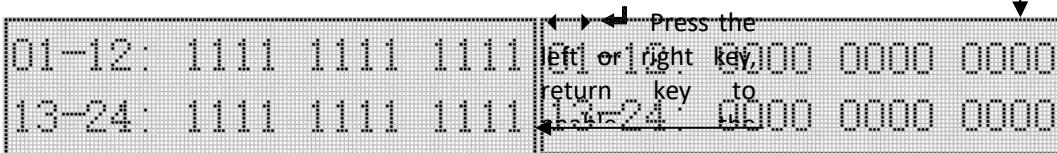

After the setting is completed, press MENU to return until whether to save the setting interface, select "Yes" by pressing the left or right button, and press Enter to confirm the saving of data and exit the setting interface. ◀ ▶◀

Example 2: View the timing task set by Example 1.

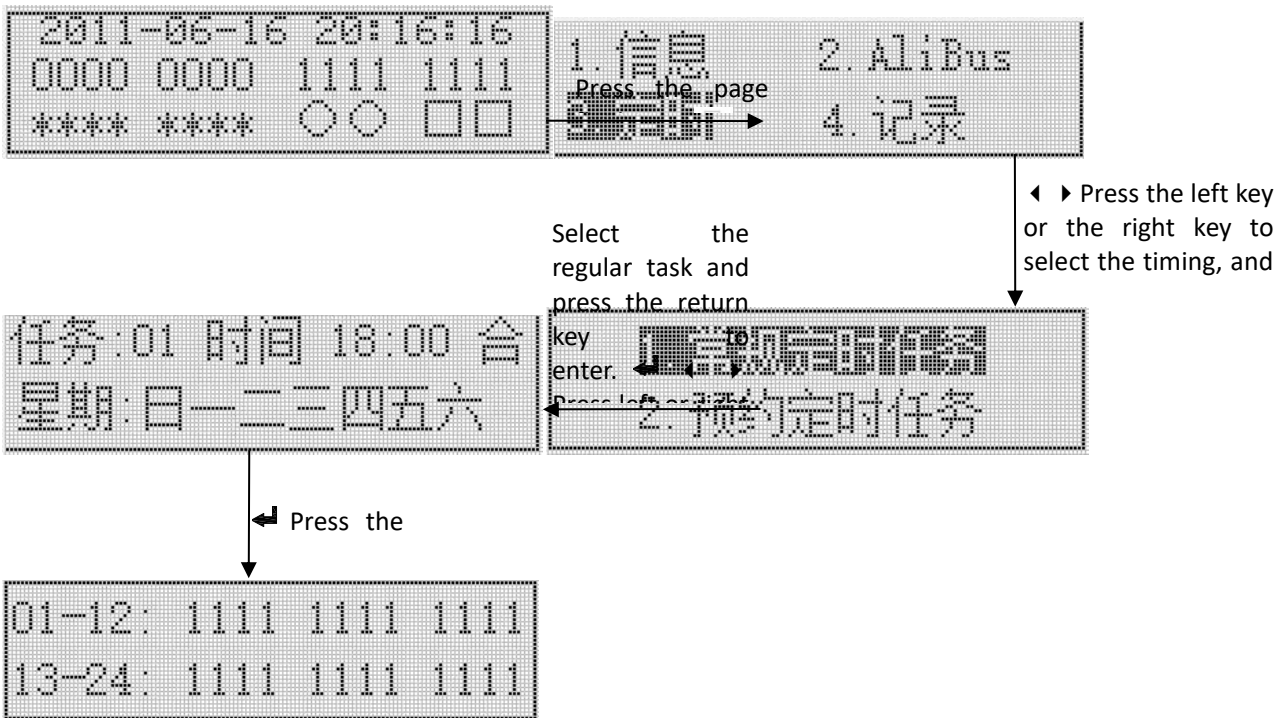

### 5.3.6 DI / DO linkage

Note: Here is the linkage description of ASL220Z-Sx / 16 and ASL220-Sx / 16. For DI / DO linkage, see "5.2 Key Operation" section for ASL210-Sx / 16.

◀ ▶ Press MENU to enter the programming password interface: press the flip key and left or right key, enter the user password (the default password is 0001), and press the enter key to enter. After the password is correct, enter the programming interface. Press the left key or right key to switch the linkage setting and press the return key to enter. ◀ ▶

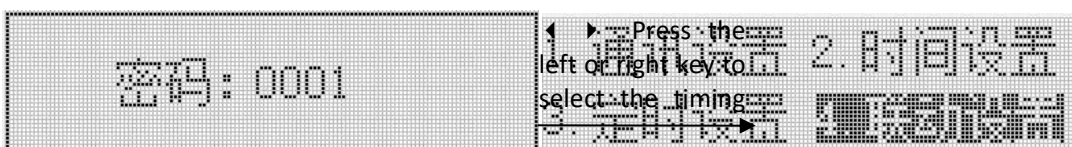

Under the "Linkage Settings" interface, the linkage function of DI1 and DI2 can be set. The

first interface can set the DI1 / DI2 linkage closing opening, mode setting, channel opening, and the execution of channel action.

If you only need to open the linkage function of part of the channel, you need to set the channel to be controlled (1 is enabled, 0 means the channel is not enabled).

If you need to control the action of some channels, some channels are divided, you need to enter the third interface to set the corresponding channel action (1 means that the channel is enabled, 0 means that the channel is not enabled).

Note: "Yes" means that DI linkage is on and "No" means that DI linkage is off.

"01" means the corresponding DI detects the incoming signal action; "010" means the detected action when the signal comes and moves again when the signal is removed.

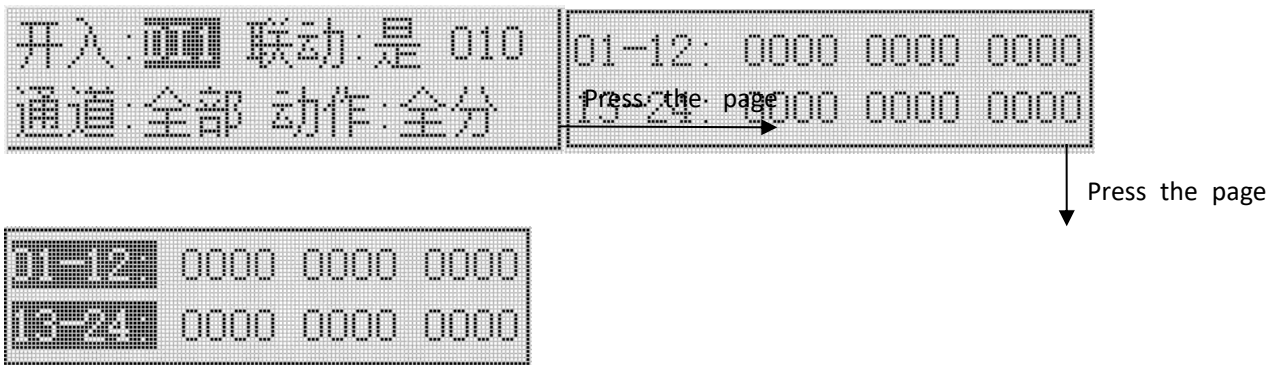

Example 3: Set DI1 linkage, DI1 and 13-24 channels; 1-12 channels and 13-24 channels.

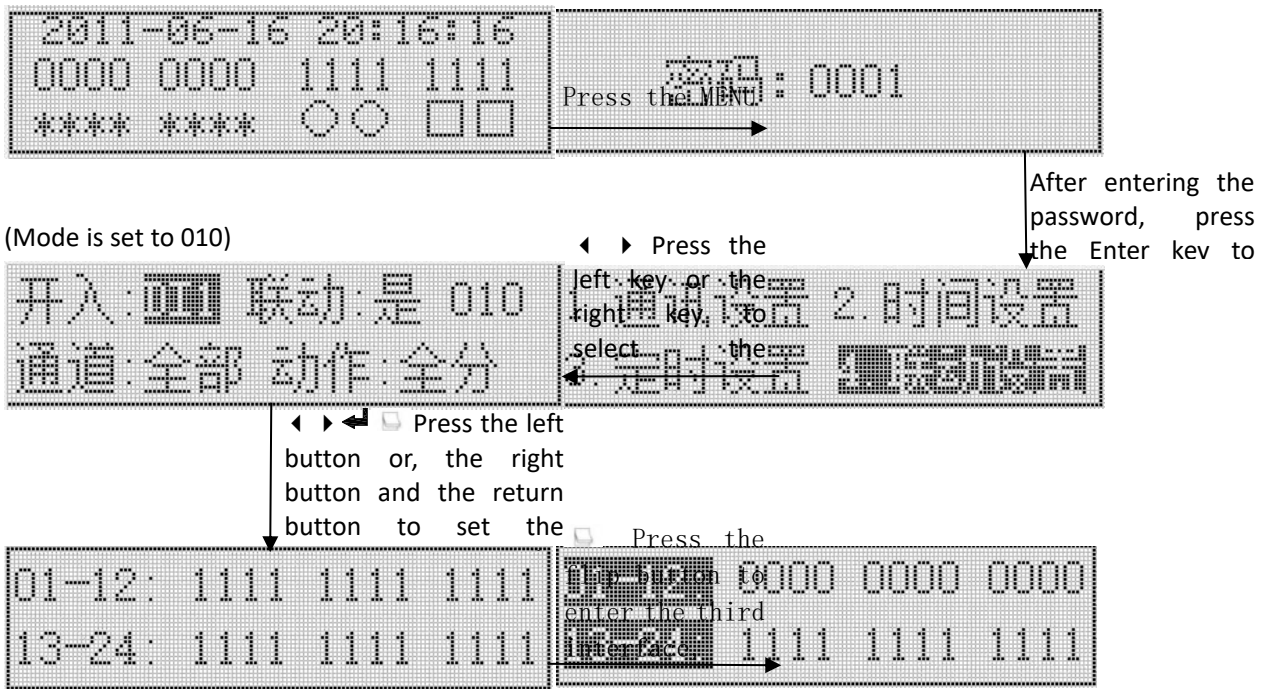

After the setting is completed, press MENU to return until whether to save the setting interface, select "Yes" by pressing the left or right button, and press Enter to confirm the saving of data and exit the setting interface. ◀ ▶ ↩

### 5.3.7 RS485 communication settings

Press MENU to enter the programming password interface: press the flip key and left or right key, enter the user password (the default password is 0001), and press the enter key to enter. After the password is correct, enter the programming interface. Press the left button or the right button

Press the left key or the right key to select Communication

to switch the communication Settings, and press the return key to enter the next level menu for setting. ◀ ▶◀▶

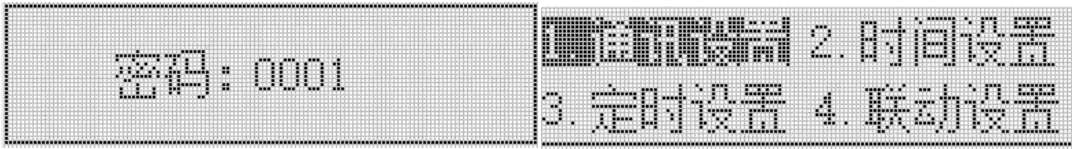

Under the "Communication Settings" interface, the RS485 mailing address and port rate can be set;

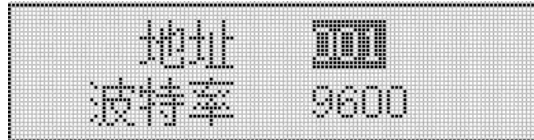

### 5.3.8 Other Parameters and information

#### 1) Information query

Under the status display interface, press the page turning key to enter the information query interface, press the left key or, the right button to switch the information, and press the return key to enter. ◀ ▶

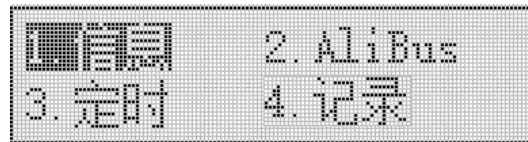

Under the information interface, the first interface displays the equipment information of the module, the second interface displays the longitude and latitude and the corresponding sunrise and sunset time, and the third interface displays the module communication information. The fourth interface begins and displays the communication information of each slave module screen by screen.

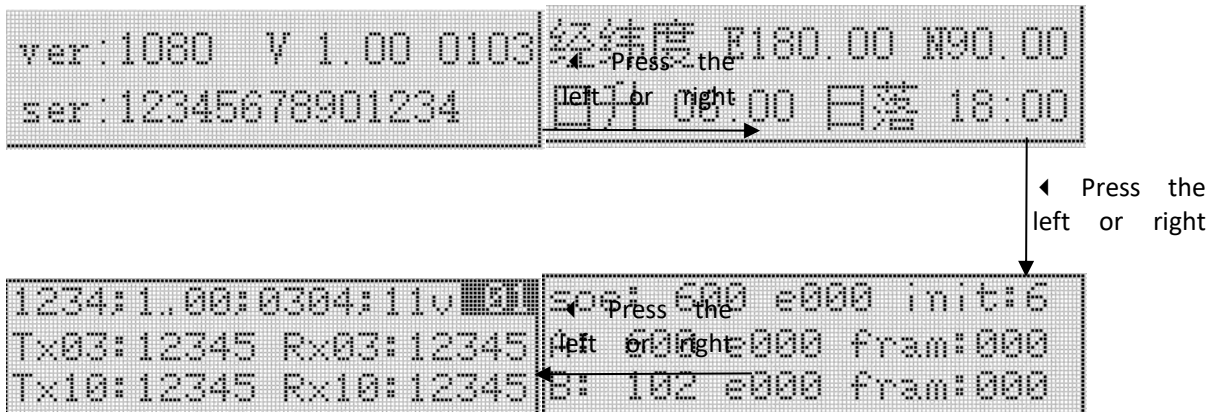

#### 2) ALIBUS query

Under the status display interface, press the page turning key to enter the information query interface, press the left key or, the right key to switch ALIBUS, and press the return key to enter.

At the ALIBUS interface, the first and second interfaces displays the communication information of the ALIBUS.

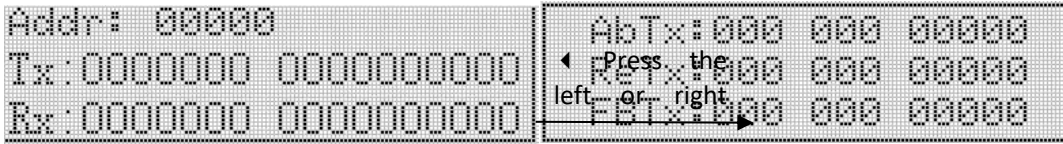

### 3) Other Settings

Press MENU to enter the programming password interface: press the flip key and left or right key, enter the user password (the default password is 0001), and press the return key to enter. After the password is correct, enter the programming interface. Press the left key or right key to switch other Settings and press the return key to enter. ◀ ▶◀▶◀▶

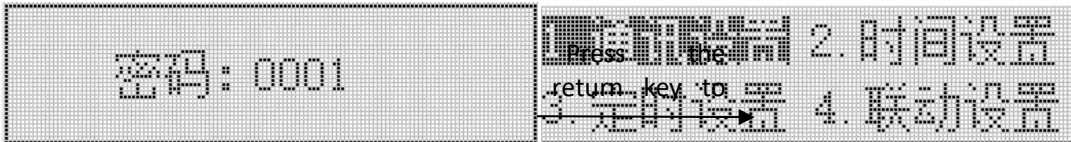

◀ ▶ Press continuously, left or right to enter the second interface select

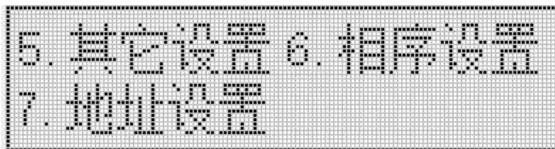

Under the Other Settings screen, you can change the password and the backlight time.

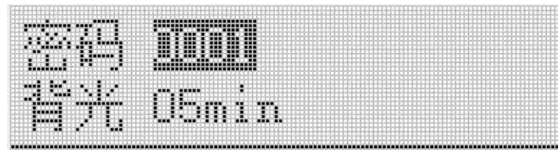

After the setting is completed, press MENU to return until whether to save the setting interface. Then select whether to save the data by pressing the left or right keys, and press the return key to confirm and exit the setting interface. ◀ ▶◀▶

### 4) Phase order setting

Press MENU to enter the programming password interface: press the flip key and left or right key, enter the user password (the default password is 0001), and press the return key to enter. After the password is correct, enter the programming interface. Press the left button or the right button to switch the phase sequence setting, and press the return key to enter. ◀ ▶◀▶◀▶

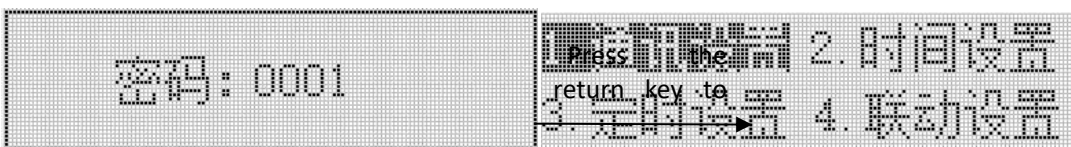

◀ ▶ Press continuously, left or right button to enter the second interface.

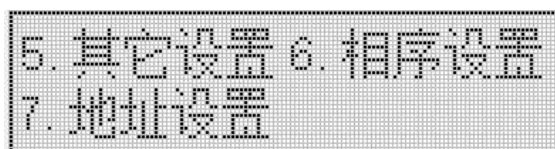

Under the "Phase sequence Settings" interface, the phase sequence of the corresponding channel



can be set or modified (A indicates that the corresponding channel phase order is phase A, B indicates the corresponding channel phase B, and C indicates the corresponding channel phase C).



Note: Phase sequence setting is the premise of realizing the function of zero. ASL220Z (Flagship) switch drives only sequence correctly The zero triggering function of the relay can be realized after connecting the voltage measurement sampling line.

5) Electric power display interface

Note: ASL220-Sx / 16 does not have the function of electric energy detection, and the interface value has no practical significance.

Press the return key in the state display interface to enter the electric energy display interface, and you can view the electric energy information of the module. The first interface displays three-phase voltage, voltage frequency and total active energy. The second interface displays the recorded channel number and the phase sequence, current, active power, current, harmonic content and active electric energy of the channel. Press the left button or the right button to switch other channel power records.

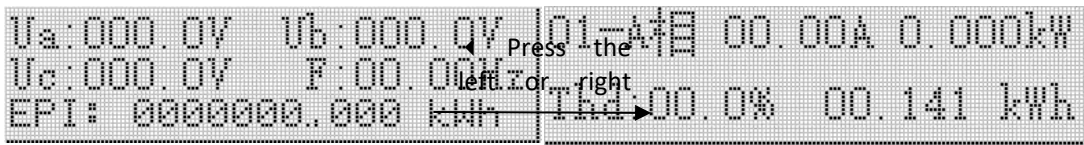

6) Change the physical address

Press MENU to enter the programming password interface: press the flip key and left or right key, enter the user password (the default password is 0001), and press the return key to enter. After the password is correct, enter the programming interface. Press the left key or right key to switch other Settings and press the return key to enter.

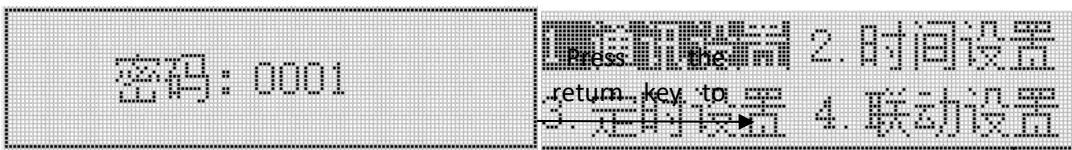

Press continuously, left or right to enter the second interface select the

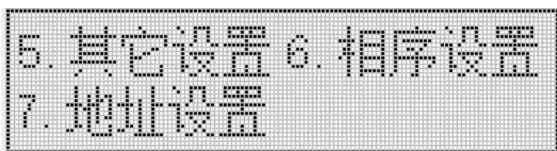

Under the Address Settings interface, you can modify physical addresses.



After the setting is completed, press MENU to return until whether to save the setting interface.

Then select whether to save the data by pressing the left or right keys, and press the return key to confirm and exit the setting interface. ◀ ▶ ↵

## 6. Functional application

All functions can be set in configuration software. The parameter settings are described below

### 6.1 The heartbeat message

- Heartbeat messages are uploaded between 0 to 255s, and 0 is not sent

### 6.2 General functions

- **Power loss state: close, open, and keep the original state unchanged**
- Power on state: off, on and keep the original state unchanged
- Control group address: 10 settings, range: 0-65535

### 6.3 Scene function

- Scene control group address can be set to 3, range 0-65535
- Different group addresses can be set with 5 scene numbers, scene number range 0-255, 0 is disabled
- Different scene numbers correspond to different control actions

### 6.4 Time function

- Delay time of lights off: range: 0-65535 in seconds
- Time control group address can be set in 3, range: 0-65535

## 7. Newsletter guide

### 7.1 Interface Overview

The switch drive supports RS485 communication and uses Modbus-RTU to communicate with our EMS integrated energy efficiency management system or third-party platform communication protocol. Default communication settings: address is 001 and port rate is 9600.

#### 7.1.1 Transmission mode

Information transmission is asynchronous, and in bytes, the communication information transmitted between the host and the slave is in 11-bit format, including 1 start bit, 8 data bits (the lowest effective bit is sent first), no parity bit, and 1 stop bit.

#### 7.1.2, information frame format

address code	FC	data field	CRC check code
1 Bytes	1 Bytes	n byte	2 Bytes

Address code: The address code is at the beginning of the frame, consisting of a byte (8-bit binary code), the decimal system is 0~255, and the maximum system can be set to 247. These bits indicate the address of the user-specified terminal device that will receive host data from and connected to it. The address of each terminal device must be unique, and only the addressed terminal



responds to a query containing that address. When the terminal sends back a response, the slave address data in the response tells the host machine which terminal is communicating with it.

Function code: The function code tells the addressed terminal what functions to perform. The following table lists the function codes used in the series of devices, and their meaning and functions.

function	definition	operate
03H	Read the data register	Get the current binary value for one or more registers
10H	Preset multiple registers	Set the binary value into a series of multiple registers

Data area: The data area contains the data required for the terminal to perform specific functions or the data collected when the terminal responds to the query. The content of these data may be numerical values, reference addresses, or set values. For example, the function code tells the terminal to read a register, and the data area needs to indicate which register to start from and how many data to read. The embedded address and data vary according to the type and the different contents between the slave.

CRC check code: The Error check (CRC) domain takes up two bytes and contains a 16-bit binary value. The CRC values are calculated by the transmission device and then attached to the data frame, where the receiving device recalculates the CRC value when receiving the data and then compares it with the values in the received CRC domain, where an error occurs if the two values are not equal.

## 7.2 Introduction to the function code

### 7.2.1 Function code 03H: read register

This function allows the user to obtain the data collected and recorded by the device and the system parameters. There is no limit to the number of data requested by the host at a time, but it cannot exceed the defined address range.

The following example is the example with address 001, ASL220-S8 / 16 switch drive with port

Host sent		transmitted information transmitter data	Send from the machine		transmitted information transmitter data
address code		01H	address code		01H
FC		03H	FC		03H
start address	high byte	00H	Byte number		06H
	lower byte	00H	The 0000H register data	high byte	16H
Number of registers	high byte	00H		lower byte	05H
				byte	

rate 9600 reading three collected basic data (each address in the data frame) to read the current time (year, month, day, day, time, minutes and seconds), where the register address of year and month is 0000H, day and hours are 0001H, minutes and seconds are 0002H, and the current time is 13:27:9 seconds on May 3, 2022.

### 7.2.2 Function code 10H: Write the register

The function code 10H allows the user to change the contents of multiple registers, and the time date in the device may be written with this function number. The host can write up to 16 (32 bytes) of data at a time.

The following example is a switch driver with address 001 and baud rate 9600, channel 1-16 writes closed operation, namely 0009H writes FFFF.

Host sent		transmitted information transmitter data	Return from the machine		return information
address code		01H	address code		01H
FC		10H	FC		10H
start address	high byte	00H	start address	high byte	00H
	lower byte	08H		lower byte	08H
Number of registers	high byte	00H	Number of registers	high byte	00H
	lower			lower	

## 7.3 Drive parameter address table

### 7.3.1 Drive real-time status address table

order number	address	parameter	read-write	scale	type
1	0x0000 high level	year	R/W	0-99 <b>Note: Series 210 this address is reserved</b>	uint8
	0x0000 low level	moon	R/W	1-12 <b>Note: Series 210 this address is reserved</b>	uint8

2	0x0001 high level	sun	R/W	1-31 <b>Note: Series 210 this address is reserved</b>	uint8
	0x0001 low level	time	R/W	0-23 <b>Note: Series 210 this address is reserved</b>	uint8
3	0x0002 high level	component	R/W	0-59 <b>Note: Series 210 this address is reserved</b>	uint8
	0x0002 low level	second	R/W	0-59 <b>Note: Series 210 this address is reserved</b>	uint8
4	0x0003 high level	week	R/W	The 0-6 stands for Sunday- -Saturday <b>Note: Series 210 this address is reserved</b>	uint8
	0x0003 low level	obligate			uint8
5	0x0004	on-off input	R	No input for bit0=0, and DI1 With bit0=1, DI1 has input No input for bit1=0, and that for DI2 Bit 1 = 1, and DI2 has input	uint16
6	0x0005	Switch output	R/W	Bit 0 = 0, and the D0 1 is not closed Bit 0 = 1, and the D0 1 is closed Bit 1 = 0, and the D0 2 does not close Bit 1 = 1, and the D0 2 is closed	uint16

7-8	0x0006	Switch state	R/W	The bit0-bit7 indicates the channel 17 - 24 and the maximum channel 24 Bit 0 = 1:10 close the channel 17 Bit 0 = 0: channel 17 points and the like	uint32
	0x0007			Blot 0-bit15 indicates lanes 1 - 16 Bit 0 = 1: channel 1 is closed bit0 = 0: channel 1 point and the like	
9-10	0x0008	Write to the fit state bit	W	The bit0-bit7 indicates the channel 17 - 24 and the maximum channel 24 Bit 0 = 1:10 close the channel 17 and the like	uint32
	0x0009			bit0-bit15 indicates channel 1-16; bit0 = 1: channel 1, and so on	
11-12	0x000A	Write to the fractional state bits	W	The bit0-bit7 indicates the channel 17 - 24 and the maximum channel 24 Bit 0 = 0: channel 17 points and the like	uint32
	0x000B			bit0-bit15 indicates channel 1-16; bit0 = 0: channel 1; and so on	

13-36	0x000C-23	Channel 1-24 state	R/W	0 points, 1 close, 0xFFFF means that the loop is not available 0xEEEE indicates the loop fault	uint16
37-60	0x0024-3B	Channel 1-24 current current	R	Accurate to 2 decimal places, in unit A <b>Note: Series 210 this address is reserved</b>	uint16
61-84	0x003C-53	Channel 1-24 current harmonic content	R	At 1 decimal place, in unit of%	uint16
85-108	0x0054-6B	Channel 1-24 active power	R	3 decimal places in kW	uint16
109-156	0x006C-9B	Channel 1-24 active electric energy	R	3 decimal places in kWh	uint32
157-204	0x009C-CB	Channel 1-24 Relay closing time	R	second	uint32
205-288	0x00CC-E3	Channel 1-24 relay closing times	R	Times	uint16
229-231	0x00E4-E6	A, B, C phase voltage	R	At 1 decimal place, in unit V <b>Note: Series 210 this address is reserved</b>	uint16
232	0x00E7	Voltage frequency	R	In 2 decimal places, in the unit of Hz <b>Note: Series 210 this address is reserved</b>	uint16

7.3.2 Parameter setting address table

number	address	parameter	Read / write	scale	type
1	0x0101	address	R/W	1-247 <b>Note: The 210 series drives only manually set the address 1-63</b>	uint8
2	0x0102	obligate			

3	0x0103	Baud rate	R/W	4800. 9600. 19200. 38400	uint8
4	0x0104 high level	The DI1 linkage function	R/W	0 is turned Off; 1 and is turned on <b>Note: The 210 series drives are only set manually</b>	uint8
	0x0104 low level	DI1 linkage mode		0 pattern 0(0->1) 1 pattern 1(0->1,1->0) <b>Note: The 210 series drives are only set manually</b>	uint8
5	0x0105	DI1 linkage, switch association loop	R/W	The bit0-bit7 indicates the channel 17-24; the maximum channel 24 Bit 0 = 0: Channel 17 is not enabled Bit 0 = 1: Enable channel 17 and the like	uint32

6	0x0106	DI1 linkage, switch association loop	R/W	Bit 0-bit15 indicates channel 1-16; bit0 = 0: Channel 1 is not enabled Bit 0 = 1: Enable channel 1 and the like	uint32
7-8	0x0107	DI1 linkage, switch associated action value	R/W	The bit0-bit7 indicates the channel 17-24; the maximum channel 24 Bit 0 = 0: channel 17 points Bit 0 = 1:10 close the channel 17 and the like	uint32
	0x0108			Blot 0-bit15 indicates lanes 1 - 16 bit0 = 0: channel 1	

				point Bit 0 = 1: channel 1 is closed and the like	
9	0x0109 high level	The DI2 linkage function	R/W	0 is turned Off; 1 and is turned on <b>Note: Series 210 this address is reserved</b>	uint8
	0x0109 low level	DI2 linkage mode		0 pattern 0(0->1) 1 pattern 1(0->1,1->0) <b>Note: Series 210 this address is reserved</b>	uint8
10-11	0x010A	DI2 linkage, switch association loop	R/W	The bit0-bit7 indicates the channel 17-24; the maximum channel 24 Bit 0 = 0: Channel 17 is not enabled Bit 0 = 1: Enable channel 17 and the like <b>Note: Series 210 this address is reserved</b>	uint32
	0x010B			Blot 0-bit15 indicates lanes 1 - 16 Bit 0 = 0: Channel 1 is not enabled Bit 0 = 1: Enable channel 1 and the like <b>Note: Series 210 this address is reserved</b>	

12-13	0x010C	DI2 linkage, switch	R/W	The bit0-bit7 indicates the channel 17-24; the	uint32
-------	--------	---------------------	-----	--	--------

		associated action value		maximum channel 24 Bit 0 = 0: channel 17 points Bit 0 = 1:10 close the channel 17 and the like <b>Note: Series 210 this address is reserved</b>	
	0x010D			Blot 0-bit15 indicates lanes 1 - 16 bit0 = 0: channel 1 point Bit 0 = 1: channel 1 is closed and the like <b>Note: Series 210 this address is reserved</b>	

### 7.3.3 Timing address table

#### 7.3.3.1 Often specified time address table

**Note: 210 Series this feature is not available**

number	address	parameter	Read / write	scale	type
1-2	0x1000 high level	longitude	R/W	-180~180	float
	0x1001 low level				
3-4	0x1002 high level	latitude	R/W	-90~90	float
	0x1003 low level				
5	0x1004 high level	Sunrise time (when)	R	0-23	uint8
	0x1004 low level	Sunrise time (points)		0-59	uint8
6	0x1005 high level	Sunset time (when)	R	0-23	uint8
	0x1005 low level	Sunset time (points)		0-59	uint8
7-8	0x1006	Timing task 1 circuit	R/W	The bit0-bit7 indicates the channel 17-24; the	uint32



		setting		maximum channel 24 Bit 0 = 1:17 channel enabled timing Bit 0 = 0: Channel 17 does not enable by analogy	
	0x1007			Blot 0-bit15 indicates lanes 1 - 16 Bit 0 = 1: Channel 1 has enabled timing Bit 0 = 0: Channel 1 is not enabled and the like	
9	0x1008 high level	Timed Task 1 Execution Time (week)	R/W	bit0-bit6 Representing the Sunday- -Saturday Bit 0 = 0: The timing is not started on that day The bit0 = 1 startup timing for that day	uint8
	0x1008 low level	Timed Task 1 Execution Time (when)		0-23 stands for 0-23, 24 for sunrise, 25 for sunset	uint8
10	0x1009 high level	Timed task 1 Execution time (points)	R/W	0-59	uint8
	0x1009 low level	Execute the operation		Timing task 1 Operation setting: 00: minutes / 01: close	uint8
11-14	0x100A-0x100D	The specific register meaning can refer to the timing task 1			
15-18	0x100E-0x1011	The specific register meaning can refer to the timing task 1			
19-22	0x1012-0x1015	The specific register meaning can refer to the timing task 1			
23-26	0x1016-0x1019	The specific register meaning can refer to the timing task 1			

27-30	0x101A-0x101D	The specific register meaning can refer to the timing task 1
31-34	0x101E-0x1021	The specific register meaning can refer to the timing task 1
35-38	0x1022-0x1025	The specific register meaning can refer to the timing task 1
39-42	0x1026-0x1029	The specific register meaning can refer to the timing task 1
43-46	0x102A-0x102D	The specific register meaning can refer to the timing task 1
47-50	0x102E-0x1031	The specific register meaning can refer to the timing task 1
51-54	0x1032-0x1035	The specific register meaning can refer to the timing task 1
55-58	0x1036-0x1039	The specific register meaning can refer to the timing task 1
59-62	0x103A-0x103D	The specific register meaning can refer to the timing task 1
63-66	0x103E-0x1041	The specific register meaning can refer to the timing task 1
67-70	0x1042-0x1045	The specific register meaning can refer to the timing task 1
71-74	0x1046-0x1049	The specific register meaning can refer to the timing task 1
75-78	0x104A-0x104D	The specific register meaning can refer to the timing task 1
79-82	0x104E-0x1051	The specific register meaning can refer to the timing task 1
83-86	0x1052-0x1055	The specific register meaning can refer to the timing task 1
87-90	0x1056-0x1059	The specific register meaning can refer to the timing task 1
91-94	0x105A-0x105D	The specific register meaning can refer to the timing task 1
95-98	0x105E-0x1061	The specific register meaning can refer to the timing task 1
99-102	0x1062-0x1065	The specific register meaning can refer to the timing task

		1
103-106	0x1066-0x1069	The specific register meaning can refer to the timing task 1
107-110	0x106A-0x106D	The specific register meaning can refer to the timing task 1
111-114	0x106E-0x1071	The specific register meaning can refer to the timing task 1
115-118	0x1072-0x1075	The specific register meaning can refer to the timing task 1
119-122	0x1076-0x1079	The specific register meaning can refer to the timing task 1
123-126	0x107A-0x107D	The specific register meaning can refer to the timing task 1

### 7.3.3.2 Scheduling address table

**Note:** 210 Series this feature is not available

number	address	parameter	Read / write	scale	type
1-2	0x1100	Schedule the timing task 1 loop setting	R/W	The bit0-bit7 indicates the channel 17-24; the maximum channel 24 Bit 0 = 1:17 channel enabled timing Bit 0 = 0: Channel 17 is not enabled, and so on	uint32
	0x1101			Bit 0-bit15 indicates lanes 1 - 16 Bit 0 = 1: Channel 1 has enabled timing Bit 0 = 0: Channel 1 is not enabled, and so on	
3	0x1102 high level	Timing time (years)	R/W	0-99	uint8
	0x1102 low level	Timing time (months)		1-12	uint8
4	0x1103 high level	Timing time (day)	R/W	1-31	uint8
	0x1103 low level	Timing time		0-23	uint8

		(when)			
5	0x1104 high level	Timing time (points)	R/W	0-59	uint8
	0x1104 low level	operate		Timing task 1 Operation setting: 00: minutes / 01: close	uint8
6-10	0x1105-0x1109	Appointment timing task 2 Please refer to the reservation timing task 1			
11-15	0x110A-0x110E	Appointment timing task 3 Please refer to the reservation timing task 1			
16-20	0x110F-0x1113	Appointment timing task 4 Please refer to the appointment timing task 1			
21-25	0x1114-0x1118	Appointment timing task 5 Specific register meaning can refer to the appointment timing task 1			
26-30	0x1119-0x111D	The appointment timing task 6 may refer to the appointment timing task 1			
31-35	0x111E-0x1122	Appointment timing task 7 Specific register meaning can refer to the appointment timing task 1			
36-40	0x1123-0x1127	Appointment timing task 8 Please refer to the appointment timing task 1			
41-45	0x1128-0x112C	Appointment timing task 9 Please refer to the appointment timing task 1			
46-50	0x112D-0x1131	Appointment timing task 10 The specific register meaning may refer to the reservation timing task 1			
51-55	0x1132-0x1136	The appointment timing task 11 Please refer to the appointment timing task 1			
56-60	0x1137-0x113B	The appointment timing task 12 Please refer to the appointment timing task 1			
61-65	0x113C-0x1140	The appointment timing task 13 Please refer to the appointment timing task 1			
66-70	0x1141-0x1145	Appointment timing task 14 Please refer to reservation timing task 1			
71-75	0x1146-0x114A	The appointment timing task 15 Please refer to the appointment timing task 1			
76-80	0x114B-0x114F	The appointment timing task 16 may refer to the reservation timing task 1			
81-85	0x1150-0x1154	The appointment timing task 17 Please refer to the			

		appointment timing task 1
86-90	0x1155-0x1159	Appointment timing task 18 Please refer to reservation timing task 1
91-95	0x115A-0x115E	The appointment timing task 19 Please refer to the appointment timing task 1
96-100	0x115F-0x1163	Appointment timing task 20 refer to reservation timing task 1
101-105	0x1164-0x1168	The appointment timing task 21 Please refer to the appointment timing task 1
106-110	0x1169-0x116D	Appointment timing task 22 refer to reservation timing task 1
111-115	0x116E -0x1172	Appointment timing task 23 refer to reservation timing task 1
116-120	0x1173-0x1177	Appointment timing task 24 Please refer to reservation timing task 1

### 7.3.4 Event record address table

#### 7.3.4.1 Record address table of opening machine

**Note: 210 Series this feature is not available**

number	address	parameter	Read / write	scale	type
1	0x1200 high level	year	R	0-99	uint8
	0x1200 low level	moon	R	1-12	uint8
2	0x1201 high level	sun	R	1-31	uint8
	0x1201 low level	time	R	0-23	uint8
3	0x1202 high level	component	R	0-59	uint8
	0x1202 low level	second	R	0-59	uint8
4	0x1203 high level	type	R	0x0F means on; 0 xF 0 indicates off	uint8
	0x1203 low level	channel 1-8	R	Bit 0 channel 1; bit7, channel 8; and so on 0 Points, 1	uint8
5	0x1204 high level	channel 9-16	R	Channel 8, bit 9; bit15, channel 16; and so on 0 Points, 1	uint8
	0x1204 low level	channel 17-24	R	Channel: bit: 0:17; bit: 7, channel: 24; and so on	uint8

				0 Points, 1	
6-10	0x1205-0x1209	The specific register meaning of the machine record 2 can refer to the machine record 1			
11-15	0x120A-0x120E	The specific meaning of the register can refer to the opening machine record 1			
16-20	0x120F-0x1214	The specific register meaning can refer to the opening machine record 1			
21-25	0x1215-0x1219	The specific register meaning of the 5 can refer to the opening machine record 1			
26-30	0x121a-0x121E	The specific register meaning may refer to the opening machine record 1			
31-35	0x121F-0x1224	The specific register meaning of open machine record 7 may refer to open machine record 1			
36-40	0x1225-0x1229	The specific meaning of the register can refer to the opening machine record 1			
41-45	0x122A-0x122E	The specific register meaning of the 9 can refer to the opening record 1			
46-50	0x122F-0x1234	The specific register meaning of the opening record 10 may refer to the opening record 1			

#### 7.3.4.2 DIDO Record address table

**Note: 210 Series this feature is not available**

number	address	parameter	Read / write	scale	type
1	0x1300 high level	year	R	0-99	uint8
	0x1300 low level	moon	R	1-12	uint8
2	0x1301 high level	sun	R	1-31	uint8
	0x1301 low level	time	R	0-23	uint8
3	0x1302 high level	component	R	0-59	uint8
	0x1302 low level	second	R	0-59	uint8
4	0x1303 high level	bit zone	R	0 xAA indicates that the record exists	uint8
	0x1304 low level	DI, DO state	R	bit0 DI1; bit1 DI2 bit4 DO1; bit5 DO2 0 Points, 1	uint8
5-8	0x1305-0x1308	DIDO record 2. Please refer to DIDO record 1			
9-12	0x1309-0x130C	DIDO record 3. Please refer to DIDO record 1			

13-16	0x130D-0x1310	DIDO record 4. Please refer to DIDO record 1
17-20	0x1311-0x1314	DIDO record 5. Please refer to DIDO record 1
21-24	0x1315-0x1318	DIDO record 6. Please refer to DIDO record 1
25-28	0x1319-0x131C	DIDO record 7 Please refer to DIDO record 1
29-32	0x131D-0x1320	DIDO record 8. Please refer to DIDO record 1
33-36	0x1321-0x1324	DIDO record 9. Please refer to DIDO record 1
37-40	0x1325-0x1328	DIDO record 10 Please refer to DIDO record 1
41-44	0x1329-0x132C	DIDO record 11 Please refer to DIDO record 1
45-48	0x132D-0x1330	DIDO record 12 Please refer to DIDO record 1

### 7.3.4.3 Switrecord address table

**Note: 210 Series this feature is not available**

number	address	parameter	Read / write	scale	type
1	0x1400 high level	year	R	0-99	uint8
	0x1400 low level	moon	R	1-12	uint8
2	0x1401 high level	sun	R	1-31	uint8
	0x1401 low level	time	R	0-23	uint8
3	0x1402 high level	component	R	0-59	uint8
	0x1402 low level	second	R	0-59	uint8
4	0x1403 high level	source	R		uint8
	0x1403 low level	obligate	R		uint8
5	0x1404 high level	number of channel	R	0x01 indicates channel 1 0x18 represents the channel 24	uint8
	0x1404 low level	CS	R	0 Points, 1	uint8
6	0x1405	Control group address	R	When the control command comes from the ALIBUS, representing the control group address 0x0001 represents the control group address 1; 0xFFFF represents the control group	uint16

				address 65535; and so on	
7-12	0x1406-0x140B	Switch record 2. Please refer to switch record 1			
13-18	0x140C-0x1412	Switch record 3. Please refer to switch record 1			
19-24	0x1413-0x1419	Switch record 4. Please refer to switch record 1			
25-30	0x141A-0x142F	Switch record 5 Please refer to switch record 1			
31-36	0x1430-0x1435	Switch record 6 specific register meaning can refer to switch record 1			
By analogy, there are 600 switch records					

## 8. Common fault analysis and troubleshooting

- If the instrument operation indicator and screen are not bright, please check whether the power supply is connected to AC220V, and then check whether the ALIBUS port is short circuit.
- The data cannot be read through the RS485 interface (ModBus \_ RTU) after power-on, please check whether the address and the port rate are consistent.

## 9. matters need attention

- Before using the product, please check whether the appearance is in good condition, and find the seller in time if it is damaged.
- Connect the wiring according to the instruction manual. Check the wiring to ensure that the wiring is correct.
- After connecting the product to the bus, make sure the operating indicator is normal. Operation the programming key to ensure that the key is stuck and the programming light is normal.
- Product installation and replacement to ensure that it is operated under power failure condition.
- The product can not directly replace the micro circuit breaker and other protection components.



amendant record

Revised edition	Revision time	Revised terms
V1.1	2022/07/08	<ol style="list-style-type: none"> <li>1. Added instructions for the ASL210 series switch drives</li> <li>2. New ASL220 series switch drive reservation task, linkage setting function, phase sequence setting and other Settings</li> <li>3. New switch record, switch record and DIDO record of ASL220 series switch driver</li> <li>4. New ASL220 series of power display function and channel recording function</li> <li>5. New switch drive timing and DI setting address table</li> </ol>
V1.2	2022/09/26	<ol style="list-style-type: none"> <li>1. Modify the shape and installation dimensions of the ASL220Z-Sx / 16 switch drive</li> <li>2. Modify the ASL220Z-Sx / 16 switch driver electrical wiring diagram</li> <li>3. New ASL210 main module dial code 7,8 function</li> <li>4. New ASL220 switch drive other parameters and information new physical address function</li> <li>5. Delete the threshold function</li> <li>6. Add unavailable remarks for the ASL210 series to the address table</li> </ol>